

CREATE A SUBMARINE

In the Stroogle Sails the Seven Seas, Grandpa Gnome builds a submarine from things around the house. You can make your own submarine like this example. Choose the parts from the sheets and cut and paste them together on a blank sheet of paper placed long ways (landscape) so your picture fits. Colour your submarine, draw faces in the windows and add an underwater background. (Pages can be expanded to A3 for younger children.)

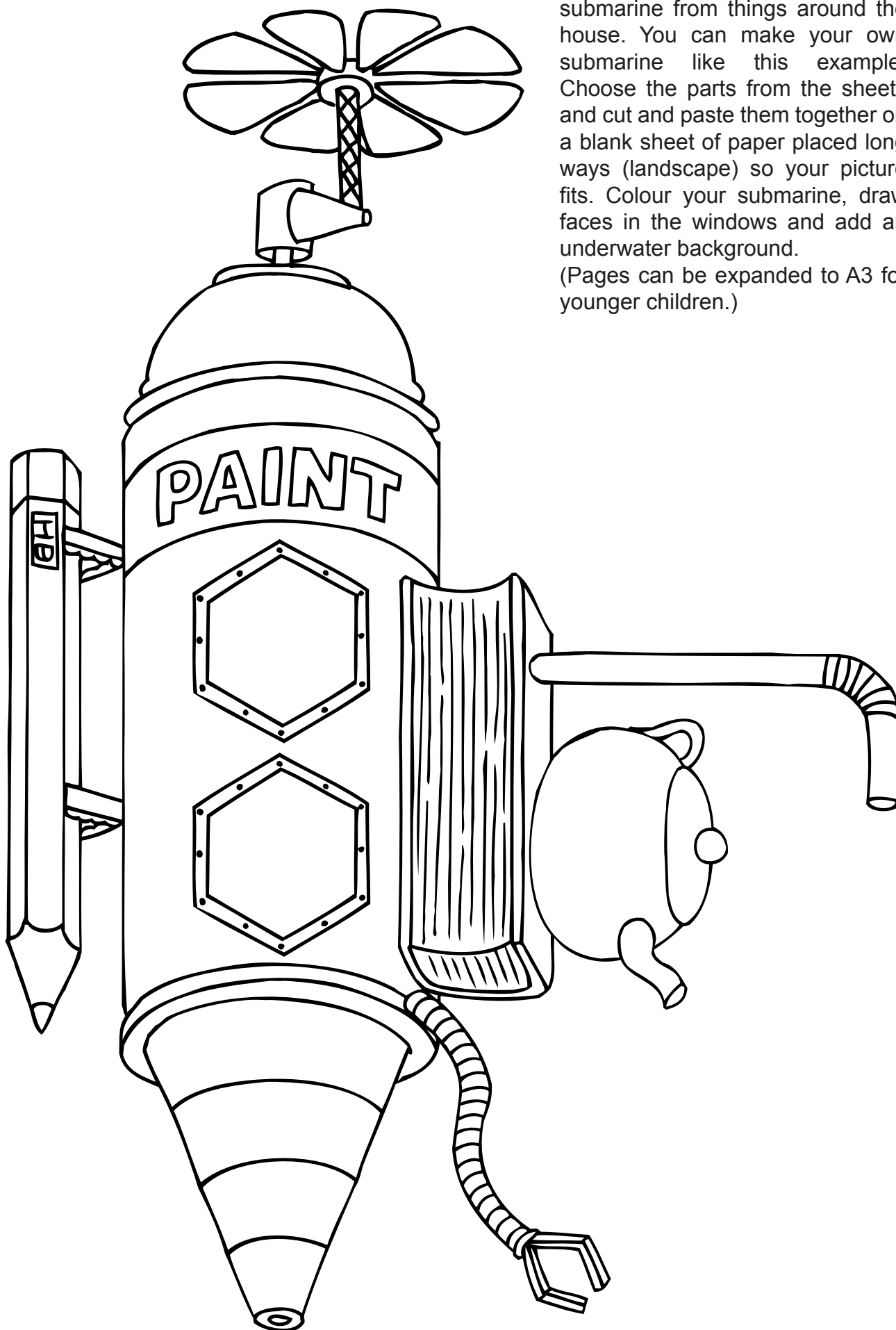

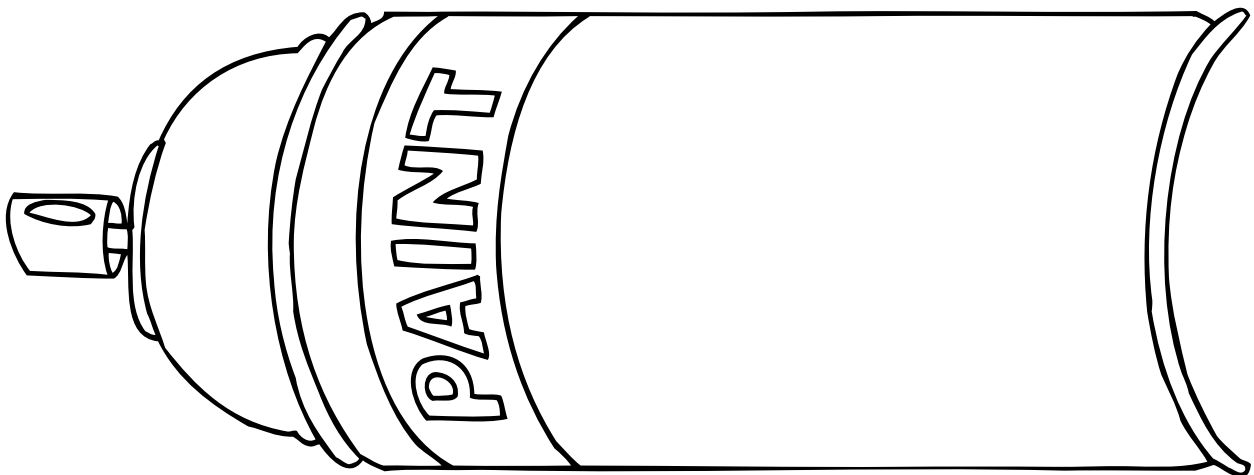

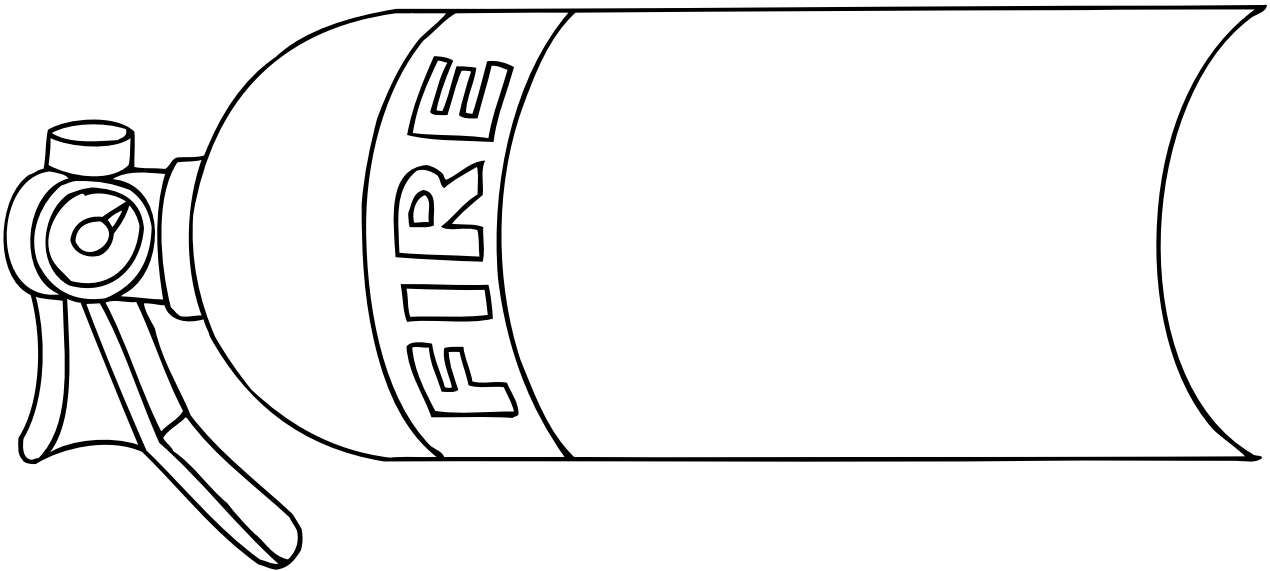
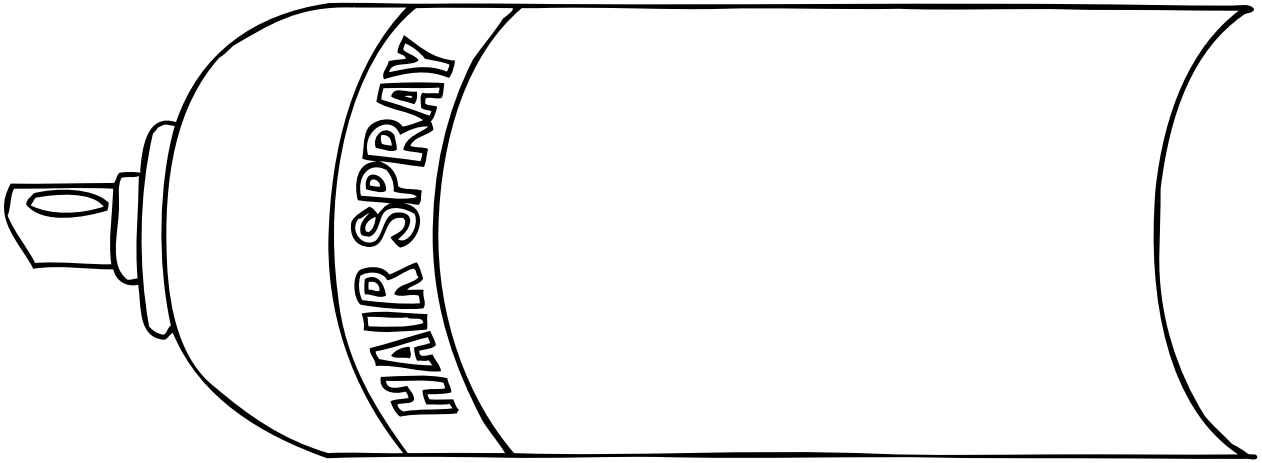
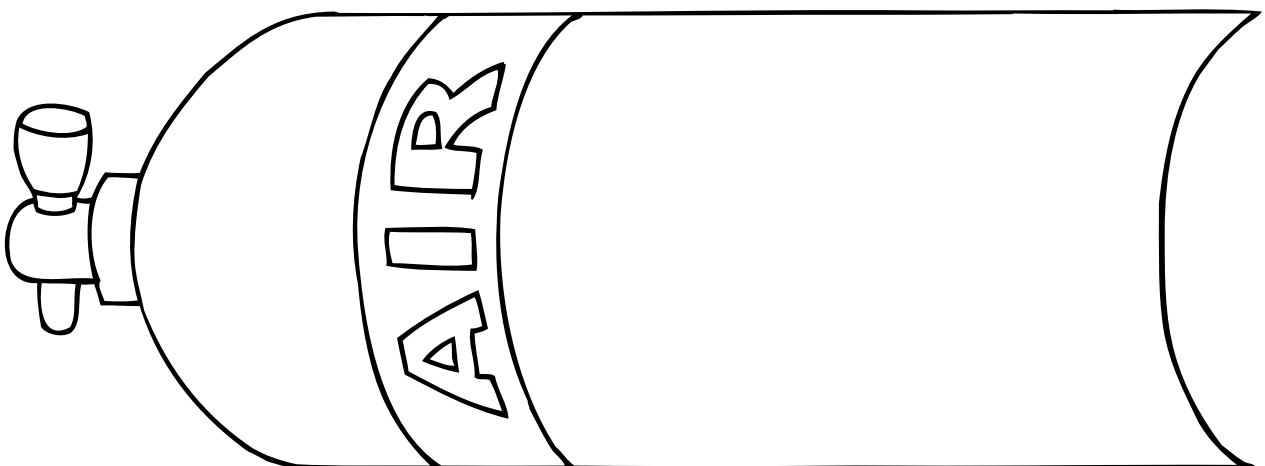
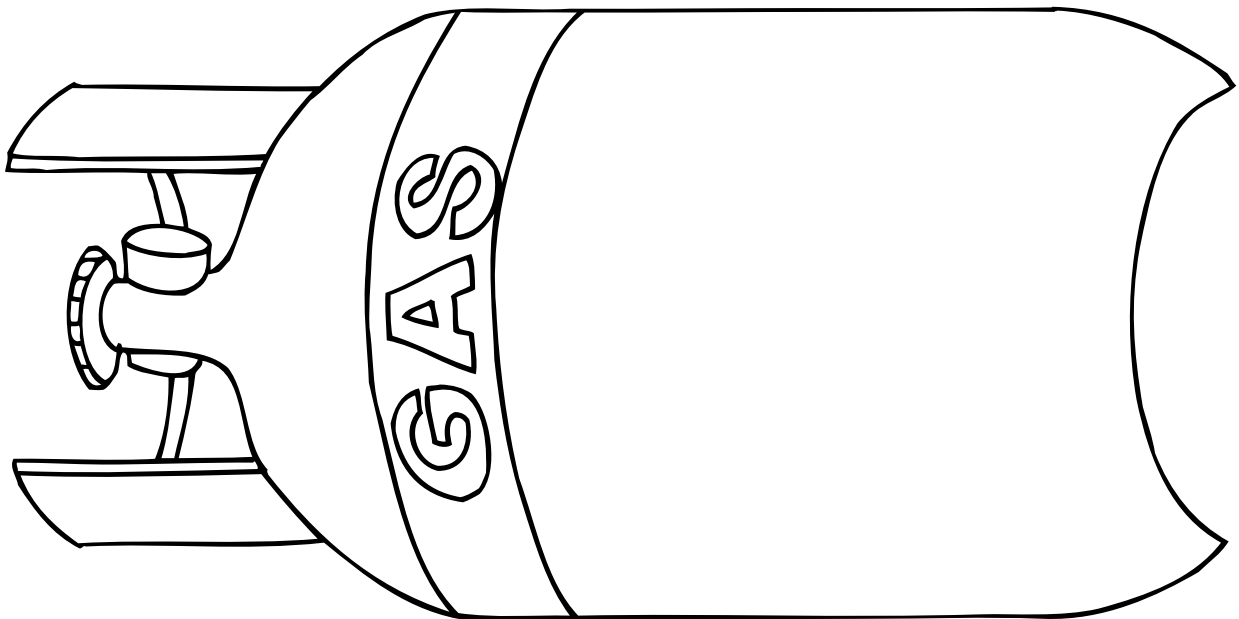
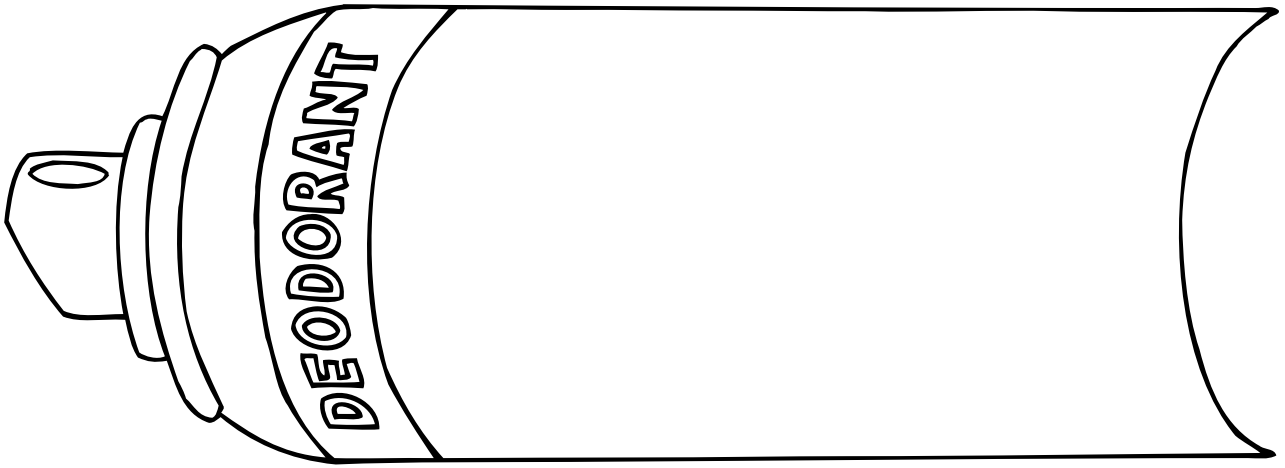

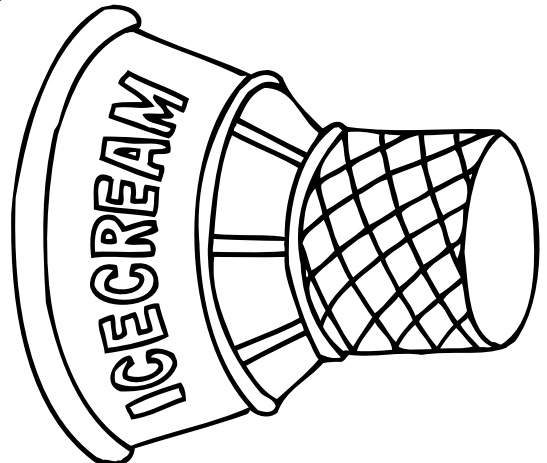
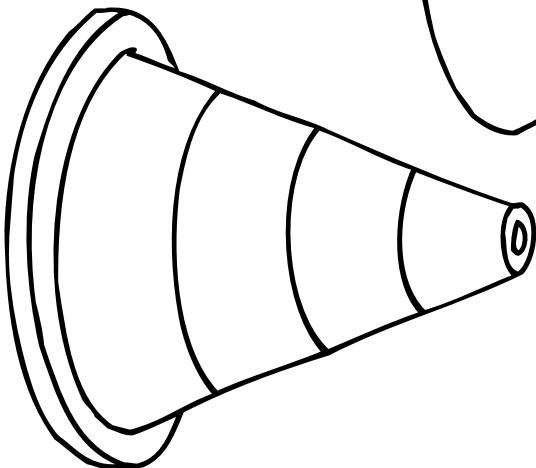
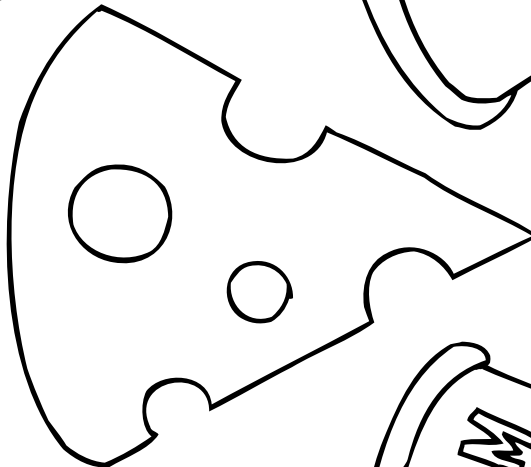
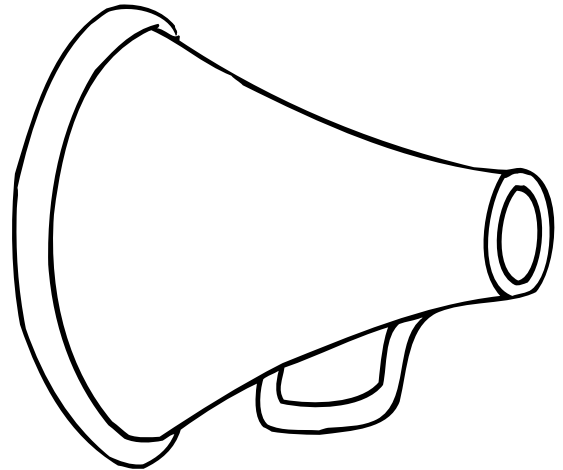
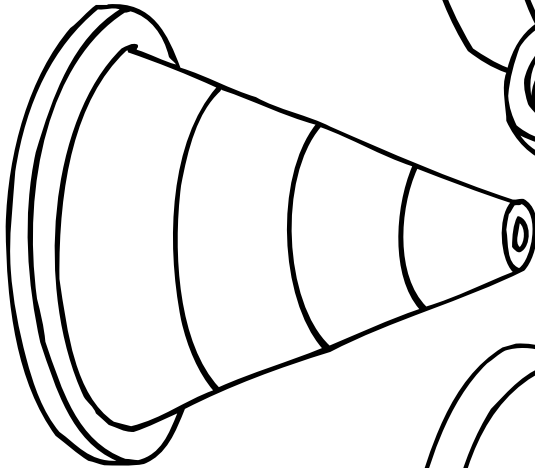
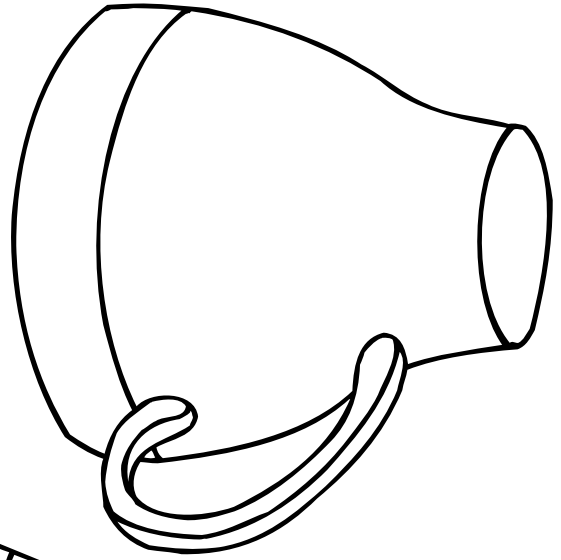

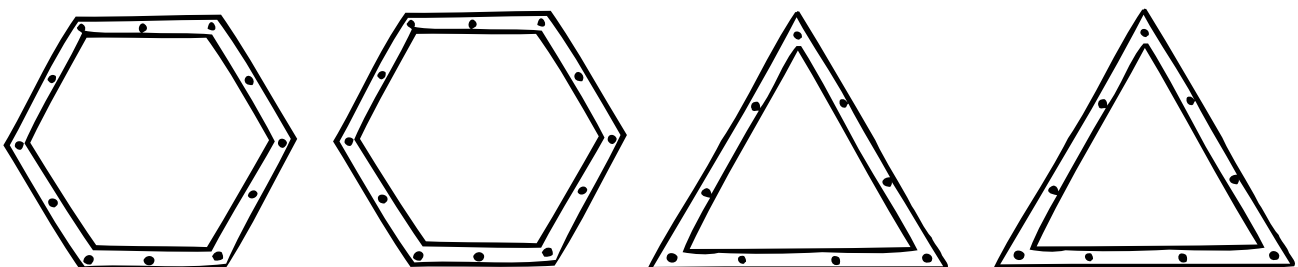
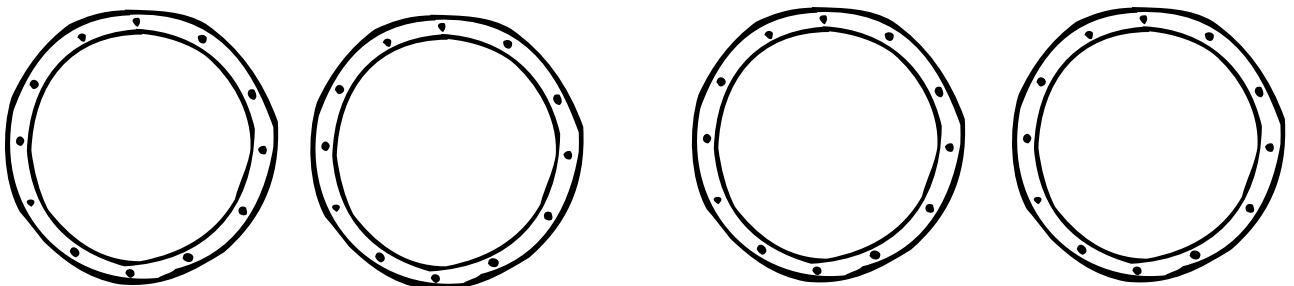
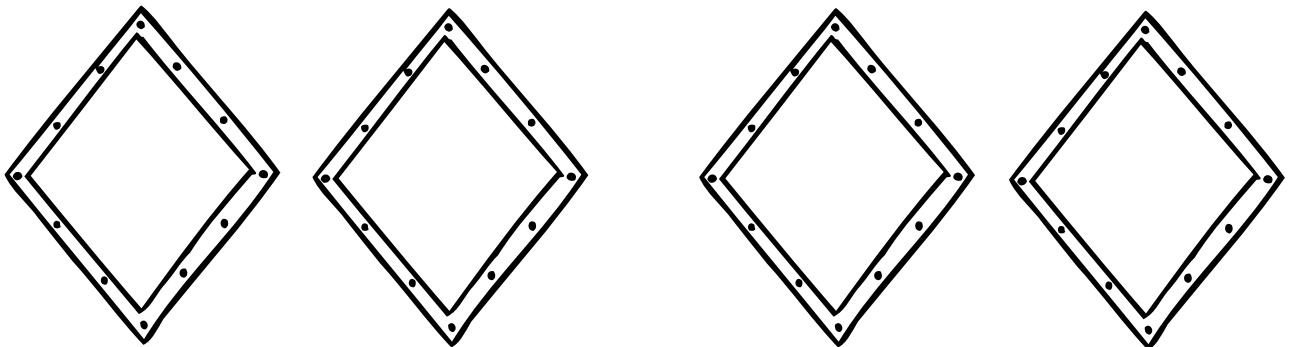
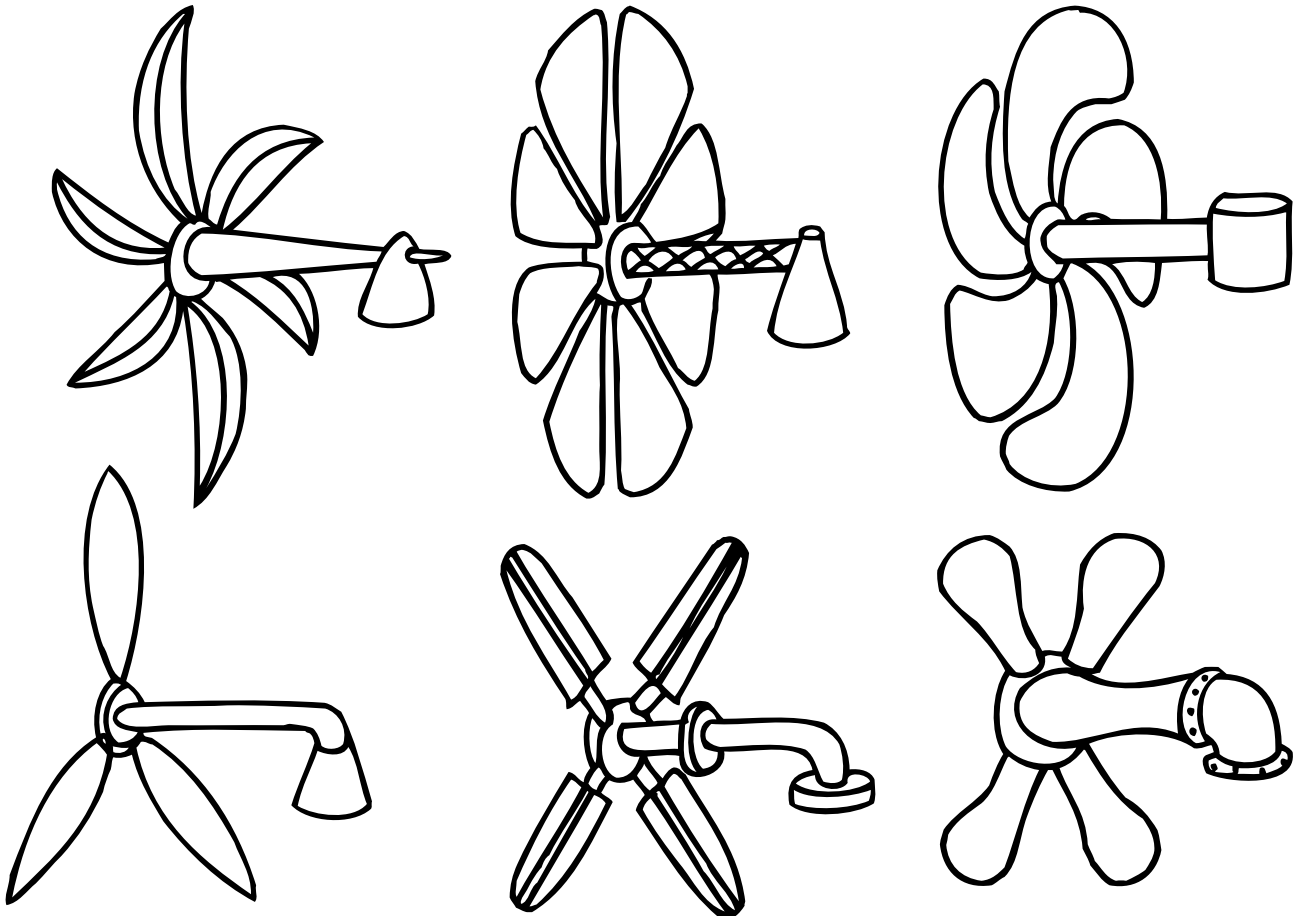

PERISCOPES & PLATFORMS

CREATE A SUBMARINE

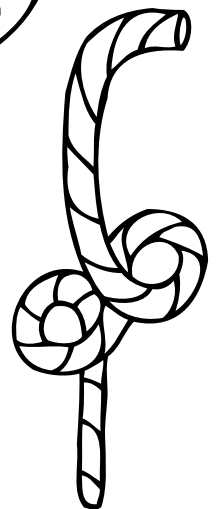
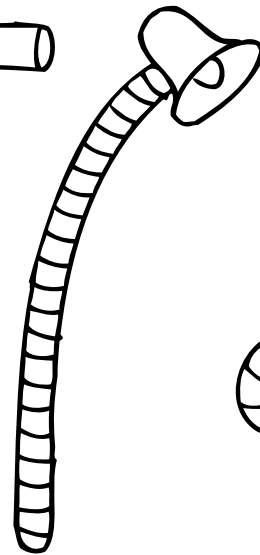
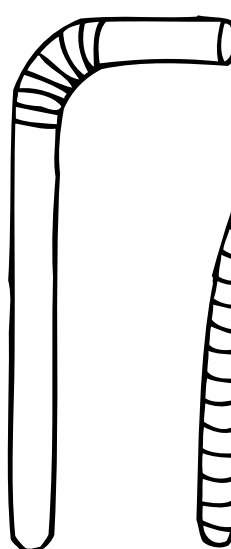
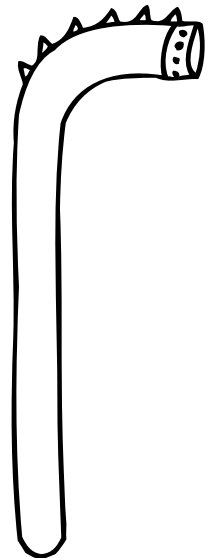
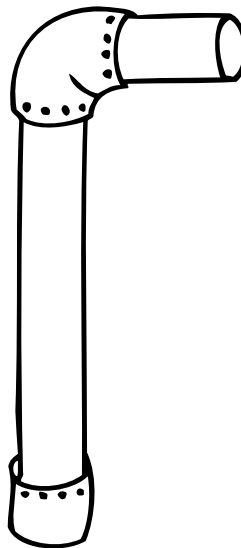
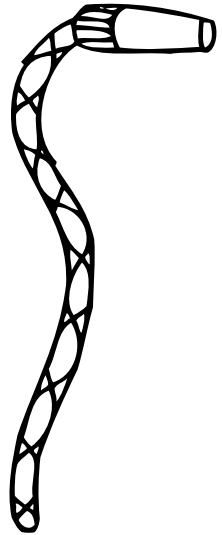
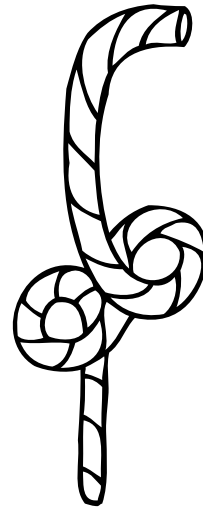
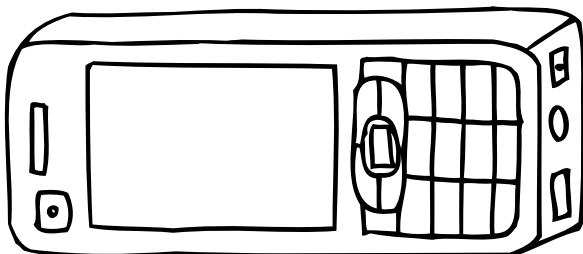
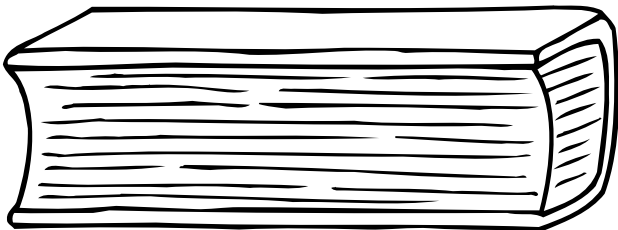
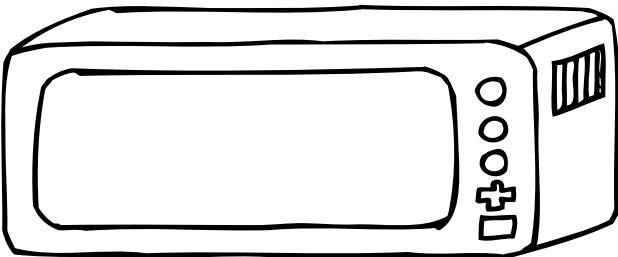
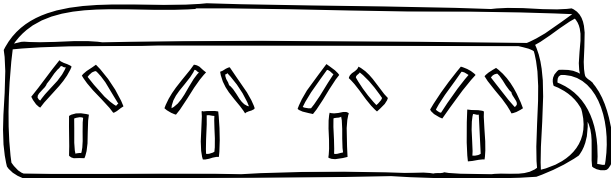
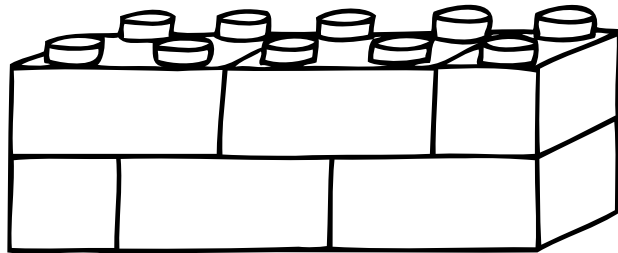
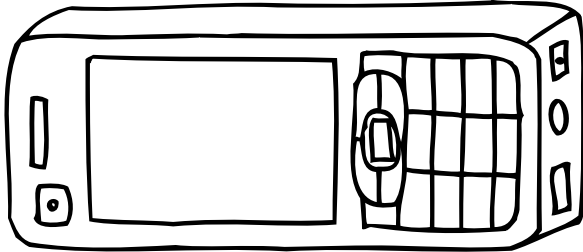
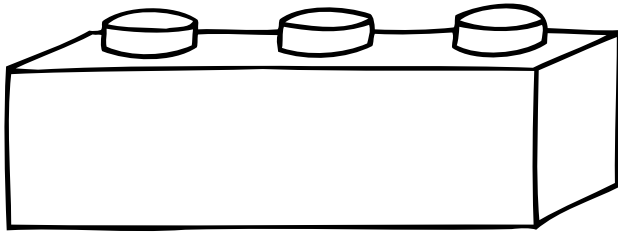

HATCHES & HANDS

CREATE A SUBMARINE

